

The eBike Display
Users Manual

KD51C-D

Product model

Intelligent LCD display of E-bike; model: KD51C-D

Specifications

- 24V/36V/48V Power Supply
- Rated working current :10mA
- The maximum working current: 30mA
- Off leakage current: <1uA
- The supply controller working current 50mA
- Operating temperature: -20°C~ 60°C
- Storage temperature: -30°C~ 70°C

Appearance and Size

Display appearance and dimension drawing (unit: mm)

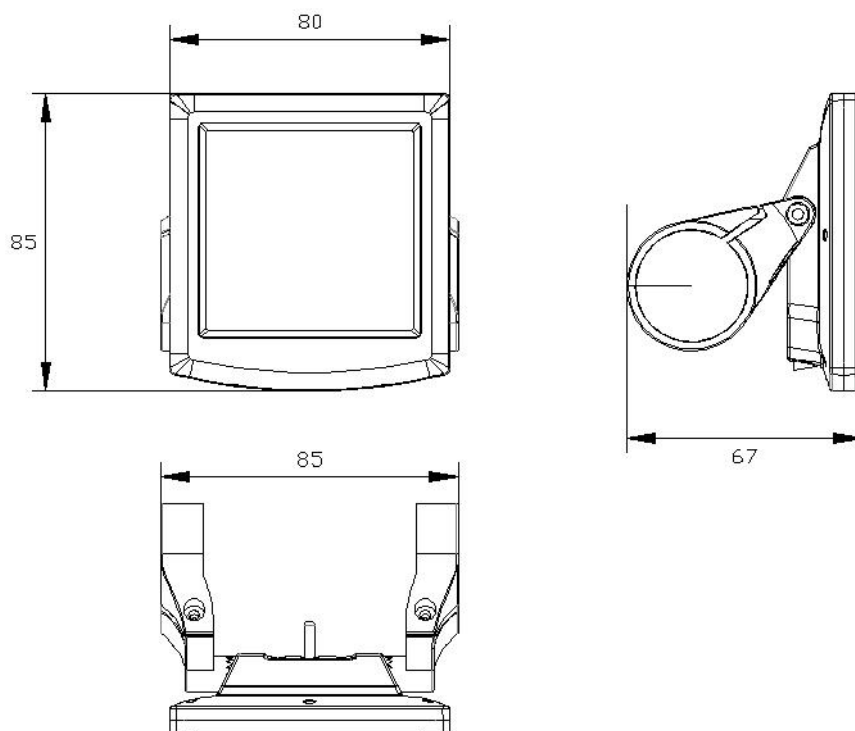

Remote appearance and dimension drawing (unit: mm)

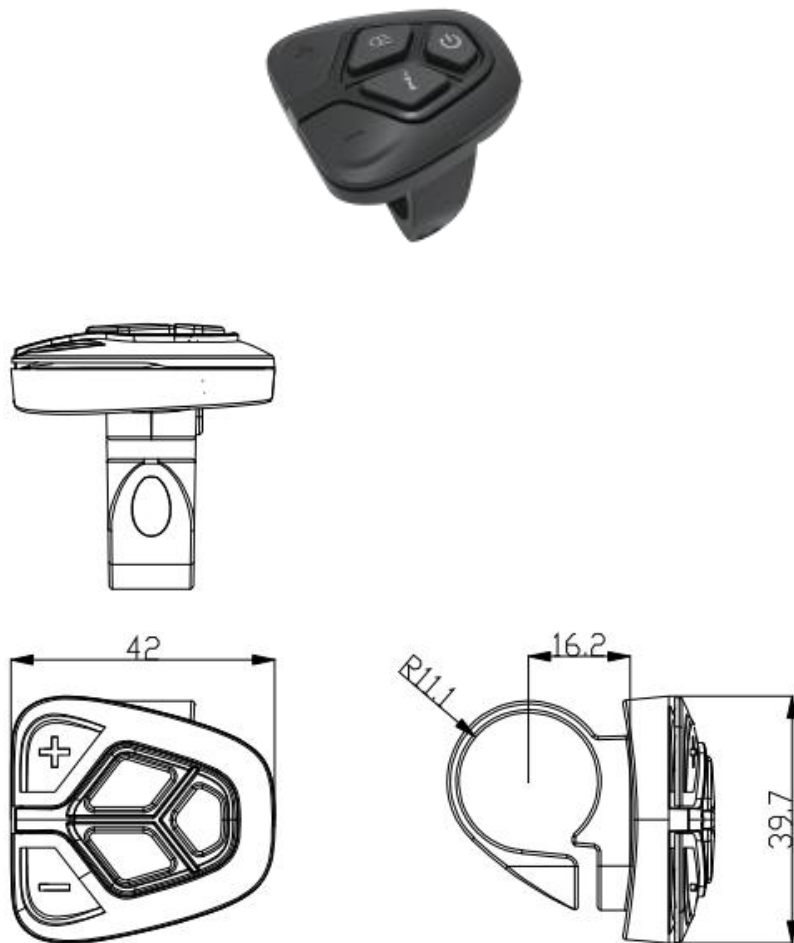

Function Summary

KD51C-D can provide a lot of functions to fit the Users needs. The indicating contents are as below:

- Battery and battery percentage indication
- Motor Power indication
- Assistance-level indication
- Speed indication (incl. running speed, Max. speed and Ave. speed)
- Odometer and trip distance
- The push-assistance function
- Trip time indication
- Backlight On/Off
- Error code indication
- Pedaling frequency indication(optional)
- USB connection indicator (optional)
- The remaining range indication(optional)
- Various Parameters Settings (e.g., wheel size, speed-limited, battery level bar, assistance level, controller limited current, password enable, etc.)

● Recover Default Settings

General Operation

◆ Switching the E-bike System On/Off

Briefly press the power button to switch on the E-bike system, and provides the power supply for the controller .To hold the power button for 2s, the E-bike system will be switched off .The E-bike system no longer use the battery power.

When switching off the E-bike system the leakage current is less than 1 uA.

■ When parking the E-bike for more than 10 minutes, the E-bike system switches off automatically.

◆ Display Interface

After switching on the E-bike system, the display will show Speed and Trip Distance. Pressing the “i” button will show more riding data as below:

Trip Distance (Km) → Total Distance (Km)→ Max. Speed (Km/h)→ Ave. Speed (Km/h)
→ Ride Time (Min.) .

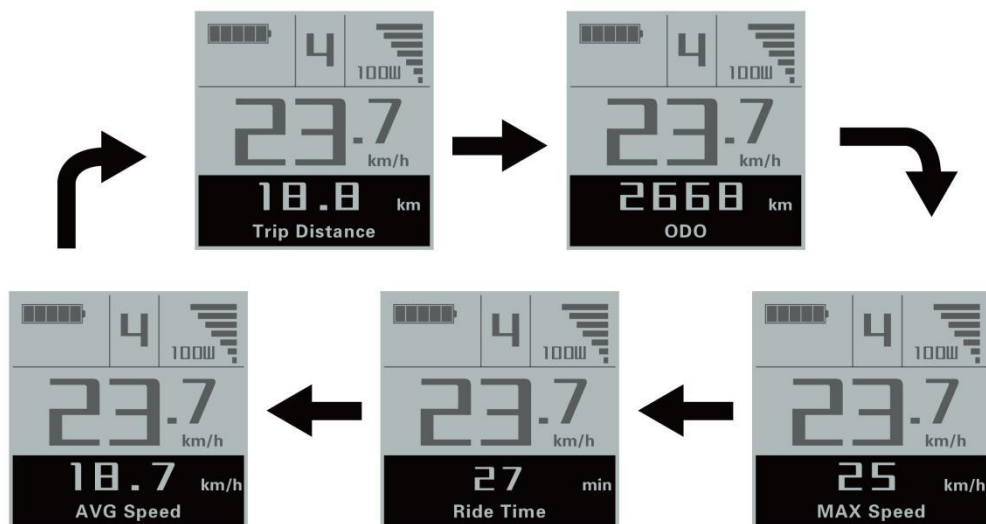

Switching display interface

◆ Switching Push-assistance Mode On/Off



To activate the push-assistance function, hold the “-” button always. After 2s, The E-bike’s drive is activated at a uniform speed of 6 Km/h. While the screen displays “” . The push-assistance function is switched off as soon as you release the “-” button on the operating unit .The E-bike system stop the power output immediately.



Push-assistance Mode

■ Push-assistance function may only be used when pushing the E-bike. Danger of injury when the wheels of the E-bike do not have ground contact while use the push-assistance function.

◆ **Switching the Lighting On/Off**

To switch on the headlight, hold the “” button for 2s. The backlight brightness is automatically reduced. In the same way to press the “” button for 2s, the lighting can be switched off.



Switching the Lighting Mode On/Off Interface

◆ **Assistance Level Selection**

Briefly press "+" or "-" button to switch the E-bike system assistance level, change the motor output power, The default assistance level ranges from level “0” to level “5”, The output power is zero on Level “0”. Level “1” is the minimum power. Level “5” is the maximum power. When you reach “5”, press the "+" button again, the interface still shows “5”, and blinks at “5” to indicate the power highest. After the power downshift reaches “0”, press the "-" button again, the interface still shows “0” and blinks at “0” to indicate the power minimum. The default value is level “1” .



Assistance Level Conversion Interface

◆ **Battery Indicator**

The five battery bars represent the capacity of the battery. The five battery bars bright when the battery is in high voltage. When the battery is in low voltage, battery frame will flash at the frequency of 1HZ to notice that the battery needs to be recharged immediately.

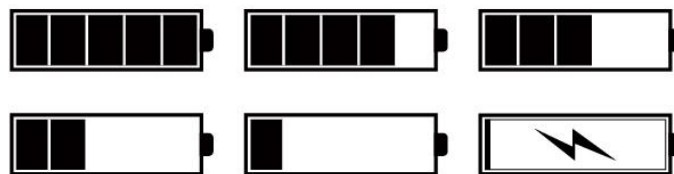

Battery Indicator

◆ **Motor Power Indicator**

The power of the motor can be read via the interface.



Motor Power Indication Interface

◆ **USB connection indication (optional)**

When the display is inserted into a USB external device, the display interface will show as below.



USB Connection Indication Interface

◆ Error Code Indication

The components of the E-bike system are continuously and automatically monitored. When an error is detected, the respective error code is indicated in text indication area.

Here is the detail message of the error code in Attached list 1.

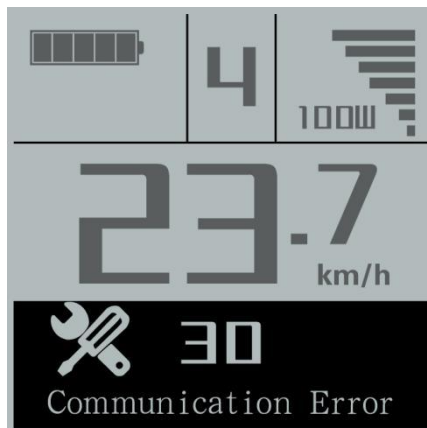

Error Code Indication

■ Make the display repaired when error code appears. E-bike will not be able to drive normally.

General Settings

Press the power button to turn on the display, to access general settings menu, hold both the “+” button and the “-” button for 2s.

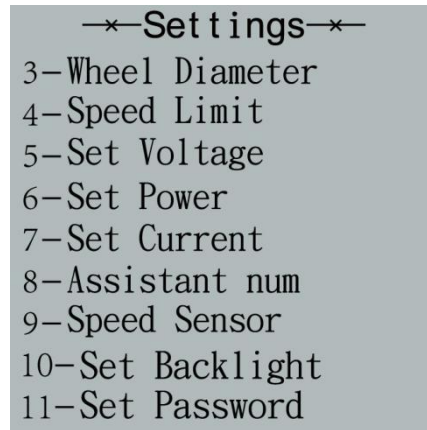

General parameter setting item selection interface

■ All the Settings are operated in the case of parking the E-bike.

◆ **Trip Distance Clearance**

Clear Trip represents trip distance clearance setting.

To clear trip distance, press the “+” button or the “-” button to select the Yes or No. Yes represents clearing a single ride distance. No represents not clearing a single ride distance.

To store a changed setting, press the “i” button and then access General Settings interface.

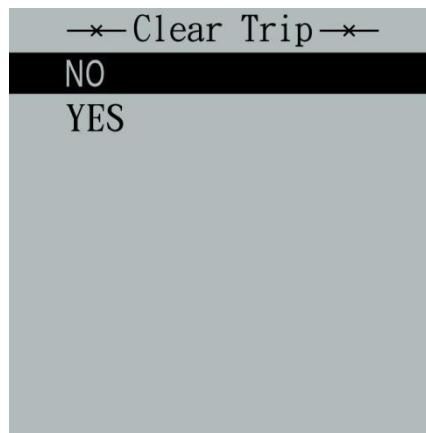

Trip Distance Clearance Settings Interface

◆ **Unit km/mile Conversion**

Set Unit represents unit settings.

To convert unit, press the “+” button or the “-” button to choose the desired setting item, and then press the “i” button to confirm.

To store a changed setting, press the “i” button and then exit general settings.

The default value is “Metric(km)”.

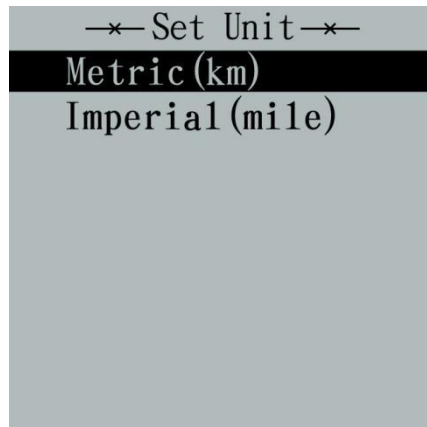

Mile and Kilometer Conversion Settings Interface

◆ Wheel Diameter Settings

Wheel Diameter represents wheel diameter settings. To change basic settings, press the "+" or the "-" button to increase or decrease until the desired value is displayed. The default value is 26 inch. To store a changed setting, press the "I" button to confirm, display "OK" words prompt operation is completed. Then access the General Settings interface.

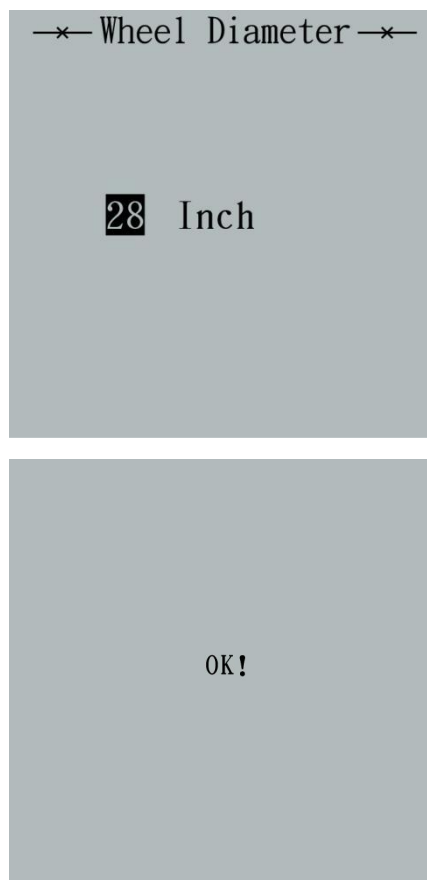

Wheel Diameter Settings Interface

◆Speed-limit Settings

The default value is 25Km/h.

Speed Limit represents the limit speed settings. When the current speed is faster than speed limit, the E-bike system will switch off automatically. Speed limit range is 12Km/h to 40Km/h.

To change basic settings, press the “+” or the “-” button to increase or decrease until the desired value is displayed. Press the “i” button to confirm, display "OK" words prompt operation is completed.

To store a changed setting and exit General Parameter Settings, hold the “i” button for 2s

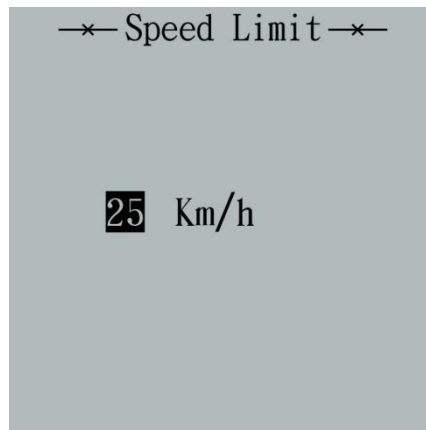

Limit Speed Settings Interface

◆Battery Power Bar Settings

Set Voltage represents voltage settings. Each bar represents a voltage value. 5 bars voltage values must be entered one by one. For example, VOL 1 is first bar voltage value. The default value is 31.5V.

To set battery power bar, press the “+” or the “-” button to increase or decrease the number. To store a changed setting and access the second bar, press the “i” button.

By analogy, after 5 bars voltage values is entered, hold the “i” button to confirm and then return to the previous menu.

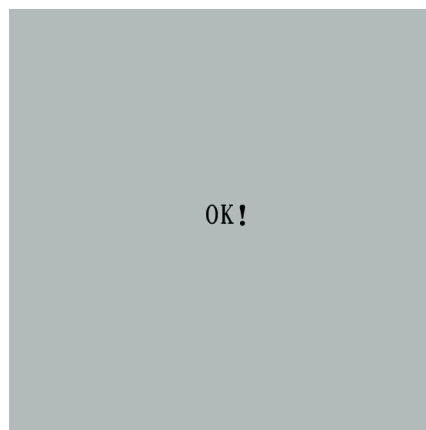
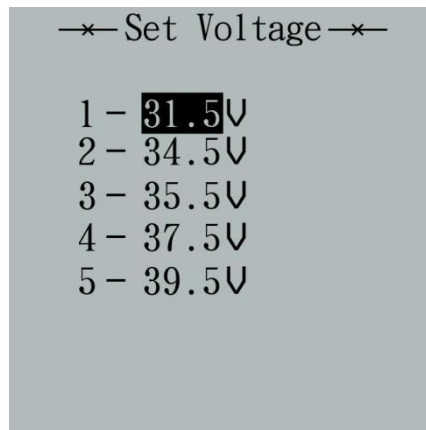

Battery Settings Indicator Interface

◆ Assistance Level Settings

Assistance Level Option

Set Power represents assistance-level settings. In assistance level settings, there are 8 modes to select: 0-3, 1-3, 0-5, 1-5, 0-7, 1-7, 0-9, 1-9. The default value is 0-5.

To change the mode of assistance-level, press the “+” or the “-” button to choose the desired mode, and then press the “i” button to confirm, then access the General settings page automatically.



PAS Mode Option Interface

PAS Ratio Settings

To modify the value of PAS ratio, press the "+" button or "-" button to choose the desired value, and then press the "i" button to confirm

For example, the range is "50 percent" of "1" level, bottom value can be modified, and the default value is 50 percent.

To store the modified setting, press the "i" button and turn to the next PAS ratio settings.

After all PAS ratio inputted, hold the "i" button for 2s to confirm and then return to previous menu.

Please refer to Attached list 2.

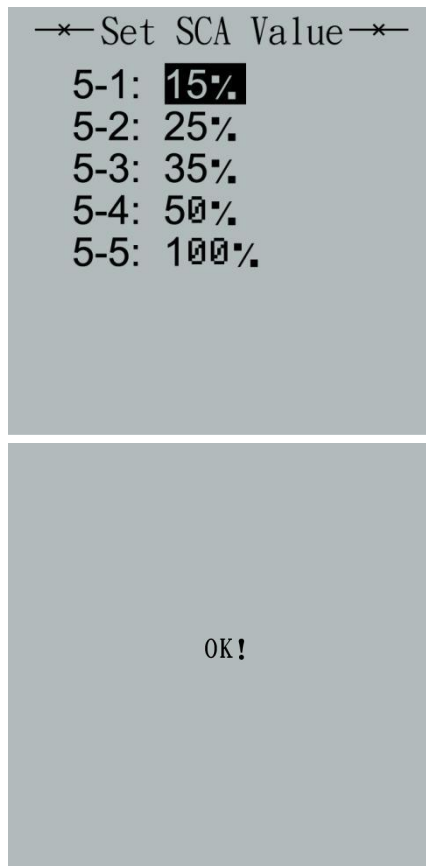

PAS Ratio Settings Interface

◆ Controller Over-current Cut Settings

Set Current represents controller over-current cut settings. The current value can be changed from 7.0A to 25.0A.

To change basic settings, press the "+" or the "-" button to increase or decrease the value of the current.

To store a changed setting, hold the "i" button and then return to previous menu.

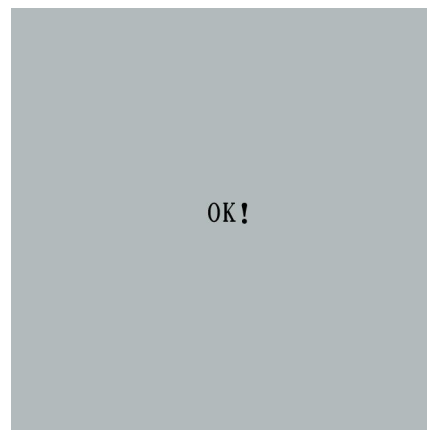
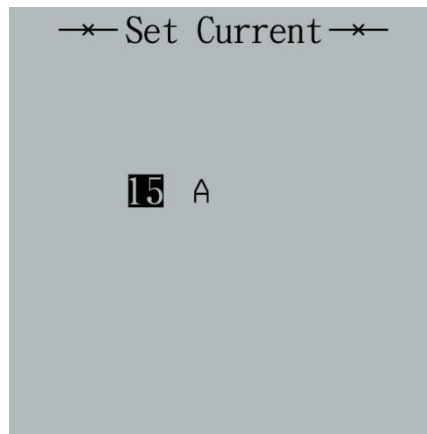

Current Settings Interface

◆ **Power Assistant Sensor Settings**

Assistant num represents the sensitivity of PAS settings. The sensitivity value is “5” to “24”.

To store a changed setting, press the “i” button and then access the general settings.

To change the sensitivity of PAS settings, press the “+” or the “-” button to select sensitivity value.

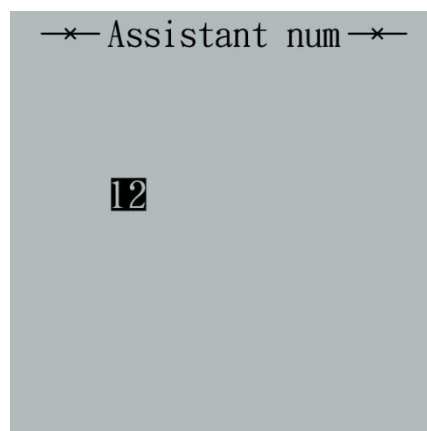

The Sensitivity of PAS Settings

◆ **Speed Sensor (optional)**

Speed Sensor represents speed sensor settings. The default value is 1

To change speed sensor settings, press the “+” or the “-” button to select the quantity of magnet head (the range is from 1 to 15).

To store a changed setting, hold the “i” button and then return to previous menu.

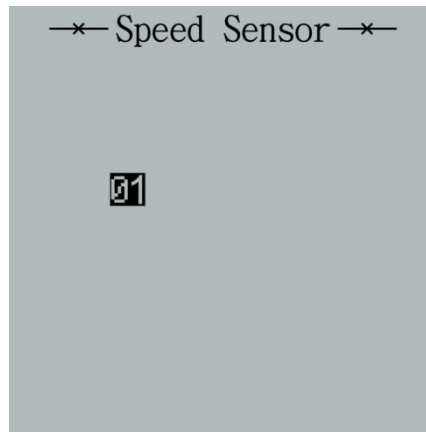

Speed Sensor Selection

◆Backlight Contrast Settings

Set Backlight represents backlight contrast settings. Level “1” is the low brightness, Level “5” is high brightness. The default level is “1”.

To modify the backlight brightness, press the “+” button or the “-” button to choose the desired setting item.

To store a changed setting, press the “i” button and then access the General settings interface.

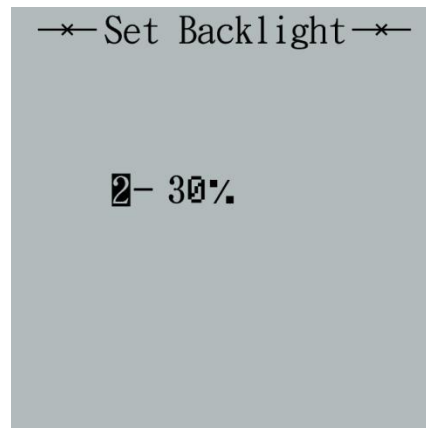

Backlight Brightness Settings Interface

◆Power-on Password Settings

Password Settings on the screen means power-on password settings. The default password is 1212.

To access the power-on password settings, press the “+” or the “-” button to modify the value and then press the “i” button to confirm digit one by one until the correct 4-digit password is completed, and then press the “i” button to access power-on password enable settings interface, otherwise stay on the password input state.

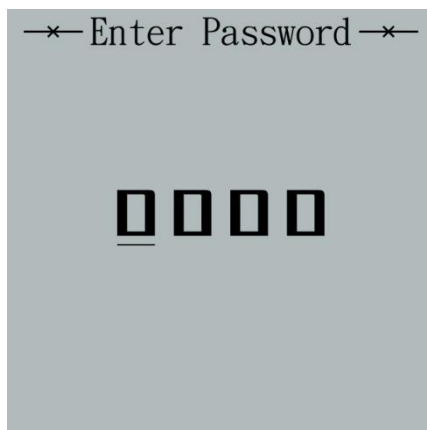

Enter Password Interface

◆Power-on Password Disable/Enable/Change

To change power-on password enable/disable settings, press the “+” or the “-” button to select. Disable means not require a power-on password. Enable means a power-on password is required.

If select Enable, press the “i” button and then access power-on password modify interface, otherwise exit the power-on password settings interface.

The default value is Enable Password.



Set Password Interface

◆Power-on Password Modify

When the display shows Password Set, Enter Password 0000, to set new power-on password, press the “+” or the “-” button to modify the value and then press the “i” button to confirm digit one by one until the new 4-digit password is completed.

To store the new power-on password, hold the “i” button for 2s and then exit

settings.

When switching the E-bike system on next time, the display will show P1,0000, please input the new password to power on.



Change Password Interface

◆Exit Settings

In the settings state, press the "i" button (short than 2s) is to confirm the input. Hold the "i" button (for more than 2s) is to store the settings, and then exit the current settings. Hold the "-" button is to cancel the operating but not storing settings data, and then return to previous menu.

■If there is not any operations in one minute, the display will exit the settings state.

Quality Assurance and Warranty Scope

I Warranty

- (1) The warranty will be valid only for products used in normal usage and conditions.
- (2) The warranty is valid for 24 months after the shipment or delivery to the customer.

II Others

The following items do not belong to our warranty scope.

- 1、 The display is demolished.
- 2、 The damage of the display is caused by wrong installation or operation.
- 3、 Shell of the display is broken when the display is out of the factory.
- 4、 Wire of the display is broken.
- 5、 The fault or damage of the display is caused by the force majeure (e.g., fire, earthquake, etc.).
- 6、 Beyond Warranty period.

◆Connection Layout

Connector line sequence

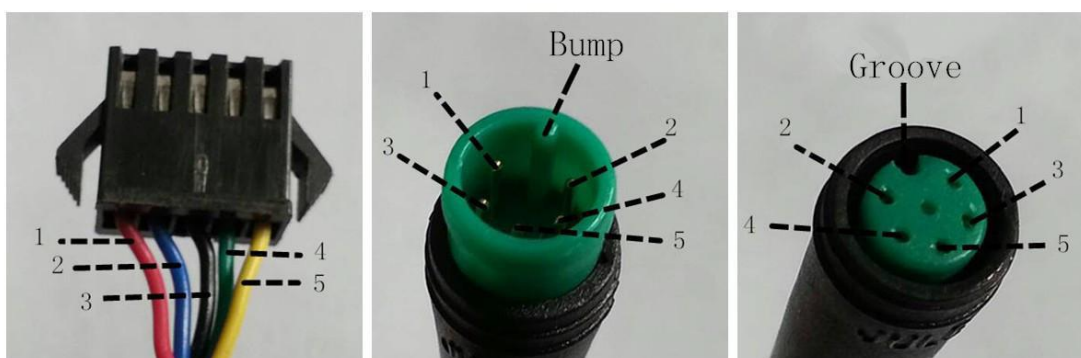

Display-side Connector

Display-side adapter

Switch wiring

Line sequence table

Line	Color	Function
1	Red (VCC)	+
2	Blue (K)	Lock
3	Green (RX)	-
4	Yellow (TX)	RX
5	Green (RX)	TX

■Some wire use the water-proof connector, users can not see the inside color.

Operation Cautions

Be careful of safe use. Don't attempt to release the connector when battery is on power.

- Try to avoid hitting.
- Do not modify system parameters to avoid parameters disorder.
- Make the display repaired when error code appears.

THIS OPERATING INSTRUCTION IS A GENERAL-PURPOSE VERSION.SOME OF THE VERSION FOR THE DISPLAY SOFTWARE WILL BE DIFFERENT FROM THE SPECIFICATION, WHICH SHOULD DEPENF ON THE ACTUAL USE VERSION.

Attached list 1: Error code definition

Error code	Definition
21	Current Abnormality
22	Throttle Abnormality
23	Motor Abnormality
24	Motor Hall Signal Abnormality
25	Brake Abnormality
30	Communication Abnormality

Attached list 2: Power assist table

Level Gear selection	1	2	3	4	5	6	7	8	9
0-3/1-3	5	7	9	—	—	—	—	—	—
0-5/ 1-5	5	6	7	8	9	—	—	—	—
0-7/ 1-7	4	5	6	7	8	9	9	—	—
0-9/ 1-9	2	3	4	5	6	7	7	8	9
